

ACCESSORIES



LARZEP offers a wide range of accessories to optimize our products performance: Hoses, Couplers, Tilting Saddles, Hollow Saddles, Flow Control Valves, Fittings, Manifolds and Pressure Gauges are available as standard.

- ✓ Wide range of standard hoses up to 10 metres and 720 bar working pressure.
- ✓ Low-flow and high-flow quick couplers available as standard.
Working pressure: 700 bar and 1.000 bar.
- ✓ Wide range of flow control valves: snubber valves, flow regulating valves with 2 or 4 outlets, manually operated check valve, single way flow regulating valve, check valve, pressure relief valve and pilot operated check valve.
- ✓ Tilting saddles highly recommended for side load application.
Hollow saddles used in hollow piston cylinders specially in pulling and tensioning operations.
- ✓ Wide range of fittings and manifolds for multiple applications.
- ✓ Glycerine filled pressure gauges for monitoring working pressure and force.
- ✓ Digital pressure gauge for monitoring working pressure.



ACCESSORIES



Models	Accessories type		Page
AP	Hydraulic Hoses		84
AZ89	Hydraulic Oil		85
AZ3	Hydraulic Couplers		86
AZ5	Flow Control Valves		88
AZ04 - AZ05 CATS	Saddles		90
AZ1	Fittings and Manifolds		92
AV - AVD - AY	Pressure Gauges		94

HYDRAULIC HOSES

- ✓ 4:1 safety factor.
- ✓ Wide range of standard hoses. Hoses can be supplied in any length on request.
- ✓ Rubber guard on both ends.
- ✓ 3/8"-NPT thread on each end. Can be supplied with couplers on one or both ends.
- ✓ Internal diameter 6,4 mm. Oil capacity: 35 cm³ per metre.
- ✓ Minimum bending radius: 115 mm.

**WARNING**

**Never disconnect the hose when the system is pressurized.
Never exceed the maximum working pressure of the hose.**



Apply 2 rounds of Teflon around all 3/8" NPT threads of the system, in the thread direction, leaving the first thread uncovered to prevent the tape breaking and entering the hydraulic system. Torque: 80 Nm.



AZ3

Coupler 3/8"-18 NPT



P.86



Type

AP - AZ

Capacity

0,8 - 10 m length

Max. pressure

700 bar

MAXIMUM WORKING PRESSURE 700 BAR

Int. ø mm	End		Pressure bar	Length						
	1	2		0,8 m	1,5 m	2 m	3 m	4 m	6 m	10 m
6,4	3/8"-NPT	3/8"-NPT	700	AP2008	AP2015	AP2020	AP2030	AP2040	AP2060	AP2100
6,4	3/8"-NPT	AZ3120	700	AP2008G	AP2015G	AP2020G	AP2030G	AP2040G	AP2060G	AP2100G
6,4	AZ3120	AZ3120	700	AP2008G2	AP2015G2	AP2020G2	AP2030G2	AP2040G2	AP2060G2	AP2100G2



- ✓ Highly refined quality oil.
- ✓ Additives to enhance film strength.
- ✓ Anti-wear properties.
- ✓ Anti-corrosion characteristics.
- ✓ Extreme pressure characteristics.
- ✓ Better conservation of the hydraulic circuits.

HYDRAULIC OIL

Model	Capacity (l)	For use with
AZ8901	5	Hand Pumps, Bottle Jacks
AZ8902	5	Powerpacks

HYDRAULIC COUPLERS



- ✓ Low-flow and high-flow couplers, from 6 to 40 litres/min.
- ✓ 700 and 1.000 bar couplers have 3/8"-18 NPTF thread.
- ✓ Male and female couplers can be supplied separately.
- ✓ Steel dust cup available for AZ3120, AZ3140 and AZ3141 couplers.
- ✓ AZ3321, AZ3325, AZ3341 and AZ3345:
ball quick couplers to guarantee easy and quick connection formerly used in cutters.
- ✓ AZ3120, AZ3140 and AZ3141: standard high-flow couplers.
- ✓ AZ3220 and AZ3240: low-flow couplers. Only used in legacy Maintenance Sets.
- ✓ All standard cylinders are supplied with AZ3140 female coupler.
- ✓ All cutters are supplied with AZ3140 female coupler.



WARNING

**Never disconnect the hose when the system is pressurized.
Never exceed the maximum working pressure of the hose.**



Apply 2 rounds of Teflon around all 3/8" NPTF threads of the system, in the thread direction, leaving the first thread uncovered to prevent the tape breaking and entering the hydraulic system. Torque: 80 Nm.





Type **AZ3**

Capacity **6 - 40 l/min**

Max. pressure **700 - 1.000 bar**

Steel dust cap available:
AZ3144 for female couplers AZ3140 and AZ3141



Rubber dust cap AZ3145 available
to suit AZ3120, AZ3140 and AZ3141 couplers



AZ3321 and AZ3325 **male** couplers are connectable with AZ3341 and AZ3345 **female** couplers

HIGH-FLOW COUPLERS 700 BAR

AZ3120

AZ3140

AZ3141

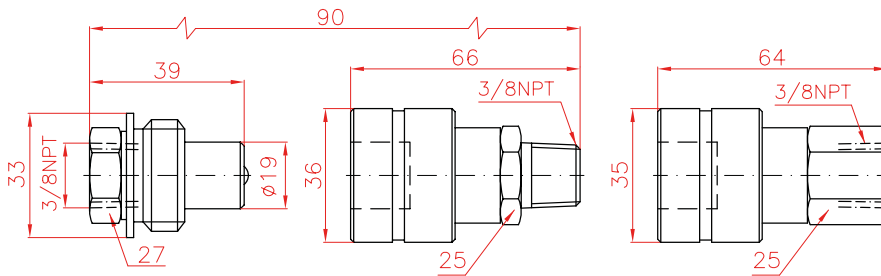

LOW-FLOW COUPLERS 700 BAR

AZ3220

AZ3240

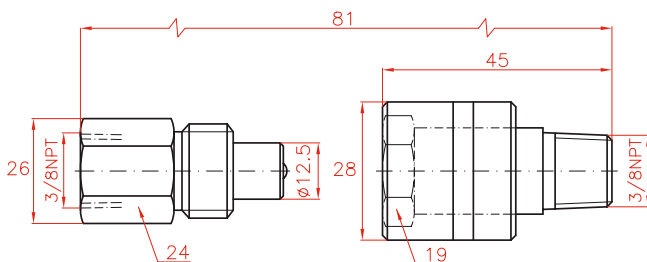

1.000 BAR BALL COUPLERS

AZ3321

AZ3341

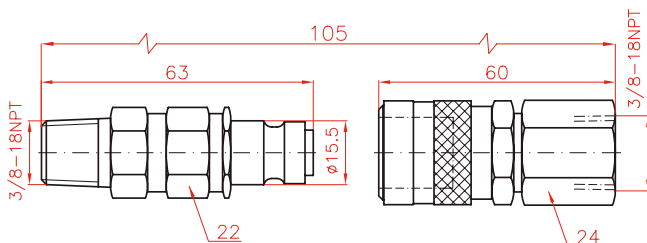

AZ3325

AZ3345

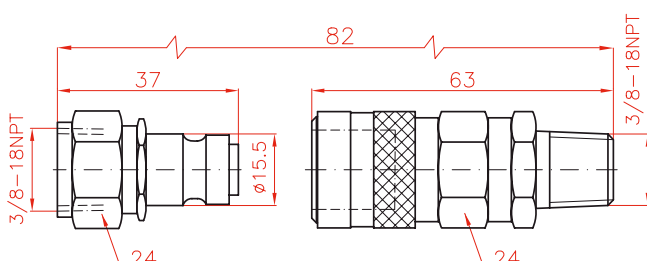

Flow l/min	Coupling	Model	Thread	Pressure
		LARZEP	NPTF	bar
40	Male	AZ3120	Female 3/8"	700
	Female	AZ3140	Male 3/8"	700
	Female	AZ3141	Female 3/8"	700
7	Male	AZ3220	Female 3/8"	700
	Female	AZ3240	Male 3/8"	700
6	Male	AZ3321	Male 3/8"	1.000
	Male	AZ3325	Female 3/8"	1.000
	Female	AZ3341	Female 3/8"	1.000
	Female	AZ3345	Male 3/8"	1.000

FLOW CONTROL VALVES



Model	SNUBBER VALVE	Symbol	
AZ5121	Used for flow control and load holding when closed. Also suitable for use as a gauge snubber.		

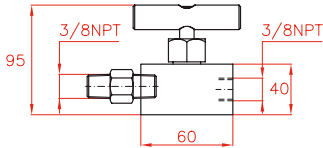

Model	MANIFOLD WITH FLOW REGULATING VALVE, 2 OUTLETS	Symbol	
AZ5122	Used for flow control of two outlets from one pressure source.		

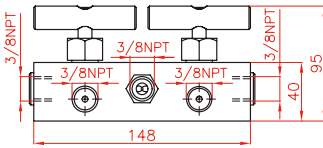

Model	MANIFOLD WITH FLOW REGULATING VALVE, 4 OUTLETS	Symbol	
AZ5124	Used for flow control of four outlets from one pressure source.		

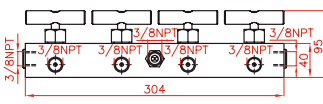

- ✓ All flow and pressure control valves are designed for 700 bar working pressure.
- ✓ All valves have 3/8"-NPT pressure ports to prevent leakage.



Type **AZ5**

Capacity -

Max. pressure **700 bar**

Model	MANUALLY OPERATED CHECK VALVE	Symbol	
AZ5200	<p>When open, allows oil flow in both directions.</p> <p>When closed, allows oil flow in one direction only, holding the load in the other one.</p>		

Model	SINGLE WAY FLOW REGULATING VALVE	Symbol	
AZ5255	<p>Similar to AZ5200, allows free oil flow in one direction and in the other, flow can be regulated or completely closed.</p>		

Model	CHECK VALVE	Symbol	
AZ5500	<p>Allows oil flow in one direction only.</p>		

Model	PRESSURE RELIEF VALVE	Symbol	
AZ5600	<p>Regulates the pressure in the hydraulic circuit.</p> <p>From 50 to 700 bar. Supplied with a 0,9 metre return line hose kit.</p>		

Model	PILOT OPERATED CHECK VALVE	Symbol	
AZ5700	<p>Load holding valve used with double-acting cylinders which is released by pilot pressure from the return line.</p>		

SADDLES



TILTING SADDLES AZ04 - CATS

- ✓ Recommended for high side-load applications.
- ✓ These saddles allow up to 5° tilt angle.
- ✓ Push-in or threaded to suit different cylinder models.

HOLLOW SADDLES AZ05

- ✓ Used in hollow piston cylinders.
- ✓ Specially used in pulling operations and as support.
- ✓ These saddles can be plain, threaded or solid.



AZ04 THREADED TILTING SADDLES

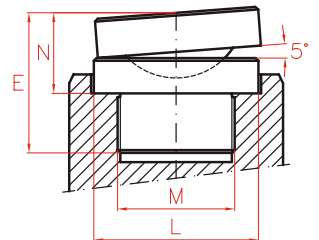

AZ04 - CATS TILTING SADDLES

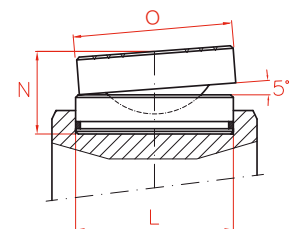

AZ05 HOLLOW SADDLES

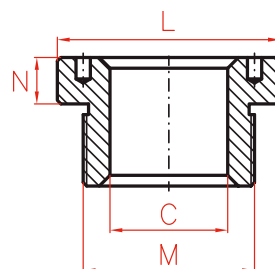

Standard Plain

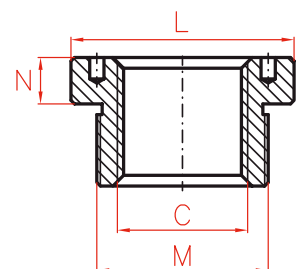

Optional Internal Thread





Type **AZ04-05, CATS**

Capacity -

Max. pressure **700 bar**

AZ04 - THREADED TILTING SADDLES

Model	L	M	N	E	Weight	Cylinder Model
LARZEP	mm		mm	mm	kg	
AZ0420	28	1"-8	29	43	0,2	SM010-D010
AZ0423	35	1"-8	29	49	0,3	SM015-D020
AZ0421	45	1 1/2"-16	28	50	0,4	SM023-SM030-D030
AZ0422	61	1 3/4"-12	38	58	0,7	D050-D075-D100
AZ0424	88	2 1/2"-12	47	82	2,5	D150
AZ0425	111	2 1/2"-12	52	107	4,5	D200
AZ0431	34	M28 x 1,5	29	44	0,3	SH012
AZ0432	48	1 9/16"-16	29	46	0,5	SH022
AZ0433	55	1 13/16"-16	37	57	0,6	SH030-SAH030-DH030-DAH030
AZ0434	80	2 3/4"-16	47	67	2,3	SH060-SAH060-DH060-DAH060
AZ0435	116	2 1/2"-12	52	76	5,5	SH100-SAH100-DH100-DAH100

AZ04 - CATS - TILTING SADDLES

Model	L	N	O	Weight	Cylinder Model
LARZEP	mm	mm	mm	kg	
AZ0401	45	36	-	0,4	SAM030-SP030-SMP030
AZ0402	61	39	-	0,8	SM050-SM075-SAM050-SP050-SMP050-SX050-SX075-DDA050
AZ0404	88	47	-	2,2	SM100-SM140-SAM100-SAM140-SP100-SMP100-SX100-SX150-DDA100
AZ0405	111	52	-	4,0	SM220
CATS50	50	34,0	71	1,0	STC030-STC050-DDC050
CATS100	71	30,0	71	1,5	STC100-DDC100
CATS150	94	39,2	97	3,0	STC140-SSC140-DDC140
CATS200	113	43,0	126	4,4	STC220-SSC220-DDC220
CATS300	140	68,5	175	10,3	STC300-SSC300-DDC300
CATS400	159	78,0	210	17,0	STC400-SSC400-DDC400
CATS500	179	77,0	230	20,0	STC500-SSC500-DDC500
CATS600	194	81,5	250	24,0	STC600-SSC600-DDC600
CATS800	224	86,5	275	32,0	STC800-SSC800-DDC800
CATS1000	249	105,5	300	46,0	STC1000-SSC1000-DDC1000

AZ05 - HOLLOW SADDLES

Standard Plain					Cylinder Model	Optional Threaded				
Model	C	L	M	N		Model	C	L	M	N
LARZEP	mm	mm		mm		LARZEP		mm		mm
AZ0531	19,5	34	M28 x 1,5	7	SH012	AZ0551	3/4"-16	34	M28 x 1,5	7
AZ0532	27,0	48	1 9/16"-16	8	SH022-SAH022	AZ0552	1"-8	48	1 9/16"-16	8
AZ0533	33,4	55	1 13/16"-16	9	SH030-SAH030-DH030-DAH030	AZ0553	1 1/4"-7	55	1 13/16"-16	9
AZ0536	56,0	80	2 3/4"-16	12	SH060-SAH060-DH060-DAH060	AZ0556	1 5/8"-5 1/2	80	2 3/4"-16	12
AZ0540	81,0	116	4"-16	13	SH100-SAH100-DH100-DAH100	AZ0560	2 1/2"-8	116	4"-16	13
AZ0545	81,0	135	4 1/4"-16	20	DH150	AZ0565	2 1/2"-8	135	4 1/4"-16	20

AZ04-05, CATS ACCESSORIES

FITTINGS AND MANIFOLDS



✓ Wide range of fittings and manifolds for multiple applications.

HEXAGON NIPPLE



Model	A	B	C	D
LARZEP			mm	mm
AZ1102	3/8"-NPT	3/8"-NPT	45	19
AZ1103	3/8"-NPT	3/8"-NPT	66	19
AZ1104	3/8"-NPT	3/8"-NPT	100	22

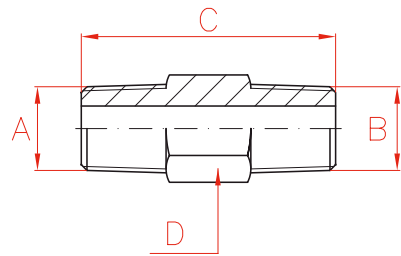

ADAPTOR



Model	A	B	C	D
LARZEP			mm	mm
AZ1112	3/8"-BSP	3/8"-NPT	36	27
AZ1113	3/8"-NPT	1/4"-BSP	36	27
AZ1114	3/8"-NPT	3/8"-BSP	36	27
AZ1122	1/2"-NPT	3/8"-NPT	43	30
AZ1123	1/2"-NPT	3/8"-BSP	45	30
AZ1124	1/4"-NPT	1/2"-NPT	28	27
AZ1125	1/4"-NPT	3/8"-BSP	36	27
AZ1126	3/8"-BSP	1/2"-NPT	48	24

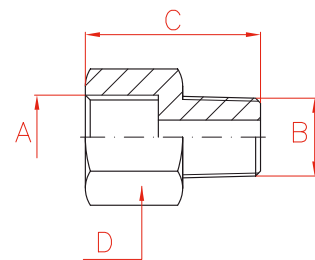

COUPLING



Model	A	B	C	D
LARZEP			mm	mm
AZ1142	3/8"-NPT	3/8"-BSP	45	27
AZ1143	3/8"-NPT	3/8"-NPT	45	27
AZ1145	3/8"-NPT	1/2"-NPT	45	30

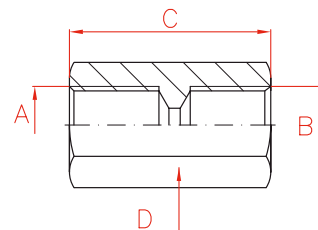



Type

AZ1

Capacity

-

Max. pressure

700 bar

PLUG



Model	A	C	D
LARZEP		mm	mm
AZ1182	3/8"-NPT	24	18

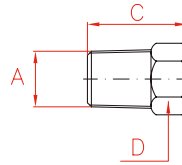

ADAPTOR ELBOW



Model	A	B	C	D
LARZEP			mm	mm
AZ1511	3/8"-NPT	3/8"-BSP	51	30
AZ1512	3/8"-NPT	3/8"-NPT	51	30
AZ1513	3/8"-NPT	1/2"-NPT	51	32

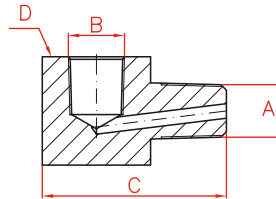

ELBOW



Model	A	B	C	D
LARZEP		mm	mm	mm
AZ1202	3/8"-NPT	40	25	12,5

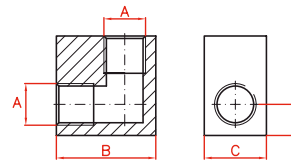

TEE



Model	A	B	C	D
LARZEP		mm	mm	mm
AZ1242	3/8"-NPT	40	25	12,5

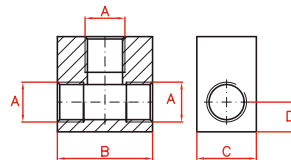

CROSS



Model	A	B	C	D
LARZEP		mm	mm	mm
AZ1282	3/8"-NPT	50	25	24

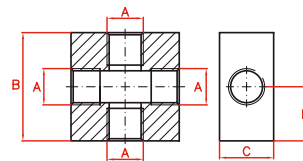

GAUGE ADAPTOR



Model	A	B	C	D
LARZEP			mm	mm
AZ1501	3/8"-NPT	3/8"-BSP	117	35
AZ1502	3/8"-NPT	1/4"-NPT	98	35
AZ1504	3/8"-NPT	1/2"-NPT	117	35
AZ1507	3/8"-NPT	1/4"-BSP	98	35

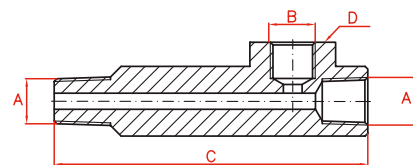

MANIFOLDS



Model	A	B	C	D	Ports
LARZEP			mm	°	No.
AZ1602	3/8"-NPT	1/2"-NPT	62	90°	2
AZ1604	3/8"-NPT	1/2"-NPT	82	60°	4
AZ1606	3/8"-NPT	1/2"-NPT	102	48°	6

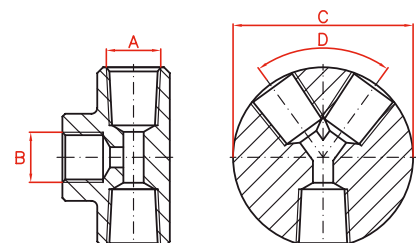

PRESSURE GAUGES



- ✓ High accuracy gauges, $\pm 1,6$ % full scale.
- ✓ Essential for monitoring working pressure or force.
- ✓ Glycerine filled gauges.
- ✓ Available as system pressure gauges or as dual scale gauges to measure load on specific cylinders.
- ✓ Digital pressure gauge AVD10008.



AZ1
FITTINGS AND MANIFOLDS



P.92

AP2
Hoses



P.84

PRESSURE GAUGES



Type **AV - AVD - AY**

Capacity **10 - 60 ton**

Max. pressure **0 - 1.000 bar**



Digital pressure gauge: **AVD10008**
Thread: 1/4"-BSP
Gauge adaptor: **AZ1507**

 **WARNING**
Do not exceed the 70% of the nominal capacity of the gauge.

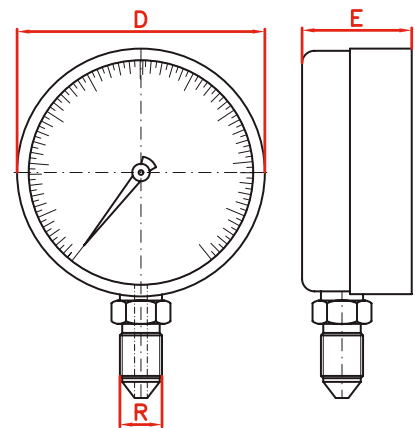

Used with	Model	End of Scale			Scale	D	E	R	Gauge Adaptor
		ton	bar	psi					
All Cylinders	AV10007	-	1.000	14.500	50 bar / 500 psi	63	31	1/4"-NPT	AZ1502
	AV10011	-	1.000	14.500	20 bar / 200 psi	80	35	1/2"-NPT	AZ1504
	AVD10008	-	1.000	14.500	0,1	80	33	1/4"-NPT	AZ1507
Press 10 ton	AY01008	10	-	-	0,5	80	35	3/8"-BSP	AZ1501
Press 20 ton	AY02008	20	-	-	0,5	80	35	3/8"-BSP	AZ1501
Press 30 ton	AY03008	30	-	-	2	80	35	3/8"-BSP	AZ1501
Press 60 ton	AY06010	60	-	-	2	100	35	3/8"-BSP	AZ1501