

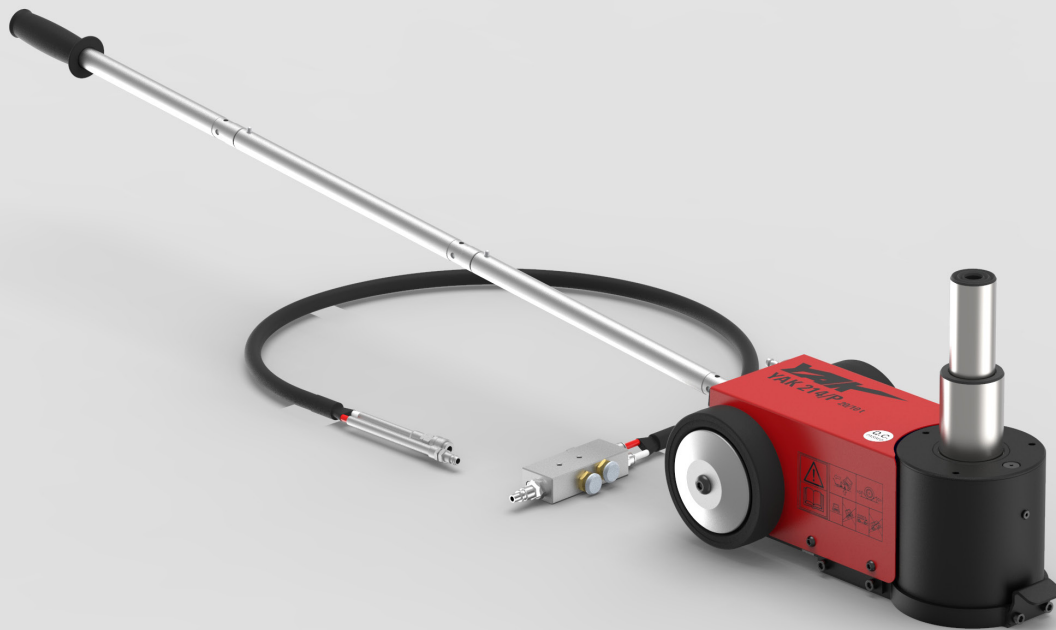

## 214/P



### Victoria

A: 27 Metcalf Street, Dandenong South, Victoria, 3175

P: (03) 9796 3744

### Western Australia

A: 260 Allen Road Forrestdale, Western Australia, 6112

P: (08) 9418 4988

### Queensland

A: Unit 8, 315 Archerfield Road, Richlands, Queensland, 4077

P: (03) 9796 3744

### New South Wales

A: Unit D, 26 Penny Place, Arndell Park, New South Wales, 2148

P: (03) 9796 3744



E: [sales@abdexhydraulics.com.au](mailto:sales@abdexhydraulics.com.au)

# AIR HYDRAULIC JACK

Extremely light, compact and efficient.  
 Made up with the best materials on the market, YAK214/P represents the technological leading edge of our product range. The high quality materials used keep YAK214/P within 15Kg/33lb weight, making it the lightest and most compact jack we ever built.

SPECIFICATIONS	YAK 214/P
Capacity	20/10 t 22/11 ton
Net weight	15 kg 33 lb
Working air pressure	8-10 bar 116-145 psi
Air waste	450 nl/min

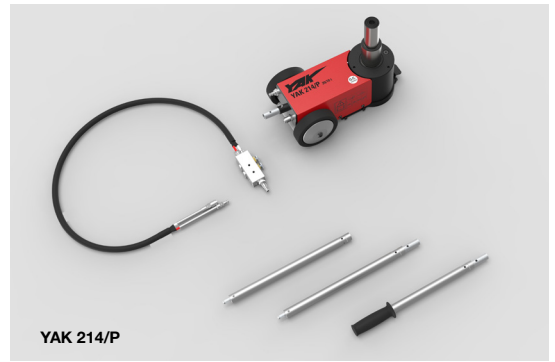

## INCLUDED ACCESSORIES

-  1x **A02376**
-  2x **A02453**

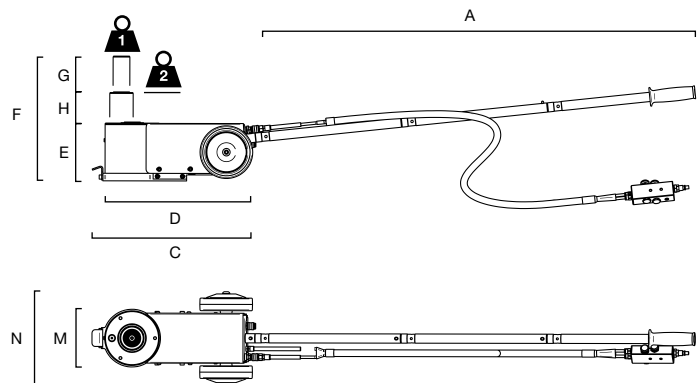

DIMENSIONS	YAK 214/P
A	354-1052 mm 13.94-41.42 in
C	383 mm 15.07 in
D	360 mm 14.17 in
E	140 mm 5.51 in
F	298 mm 11.73 in
G	86 mm 3.39 in
H	72 mm 2.8 in
M	138 mm 5.43 in
N	223 mm 8.77 in



	10 t 11 ton
	20 t 22 ton



**A04564**  
TROLLEY BOX INCLUDED

